



8 Pie SD Series Pizza Ovens Specifications

Model No. SD866, SD1066

Phone: (631) 226-6688

FAX: (631) 226-6890



TOP
SD 866/1066

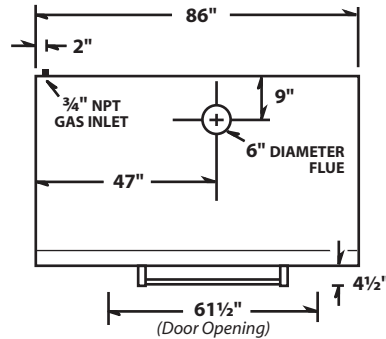

SIDE
SINGLE SD 866

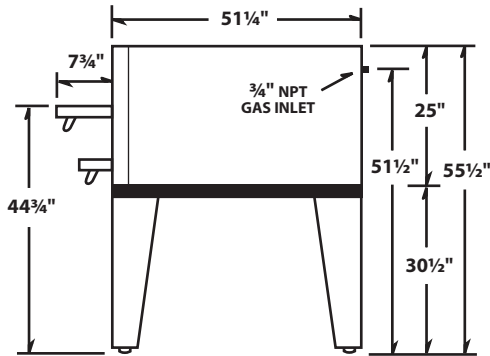

SIDE
SINGLE SD 10866

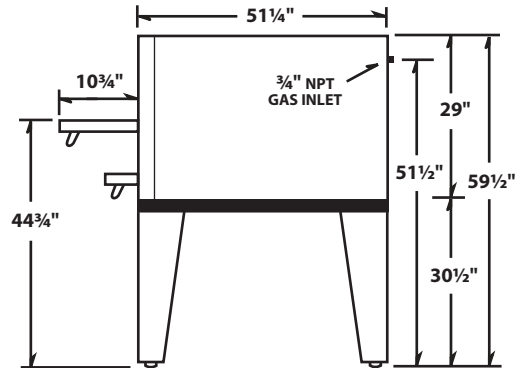

SIDE
STACKED SD 866

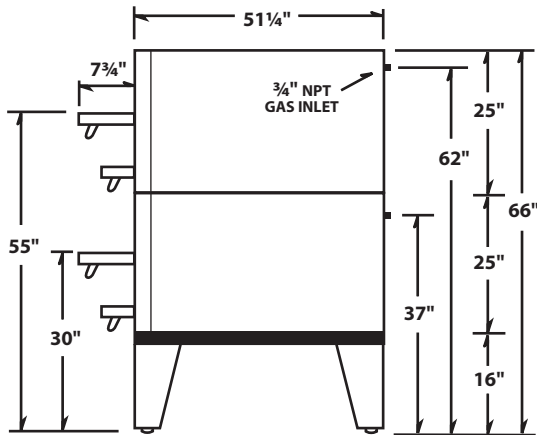

SIDE
STACKED SD 10866

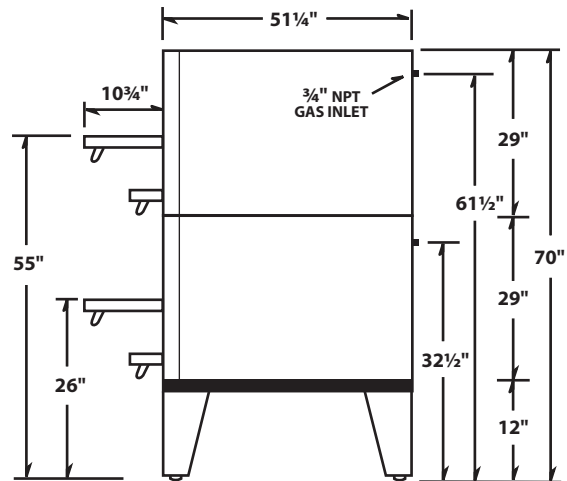

specifications

	SD 866 Single	SD 866 Stacked	SD 10866 Single	SD 10866 Stacked
Height	55 1/2"	66"	59 1/2"	70"
Depth x Length	51 1/4" x 86"	51 1/4" x 86"	51 1/4" x 86"	51 1/4" x 86"
Cooking Surface	44" x 66"	44" x 66" x 2	44" x 66"	44" x 66" x 2
BTUs	LP: 120,000 NAT: 130,000	LP: 120,000 x 2 NAT: 130,000 x 2	LP: 120,000 NAT: 130,000	LP: 120,000 x 2 NAT: 130,000 x 2
Shipping Weight	1,625 lbs.	3,200 lbs.	1,900 lbs.	3,350 lbs.
Pizza Pie Capacity	(8) 16" Pies	(16) 16" Pies	(8) 16" Pies	(16) 16" Pies